

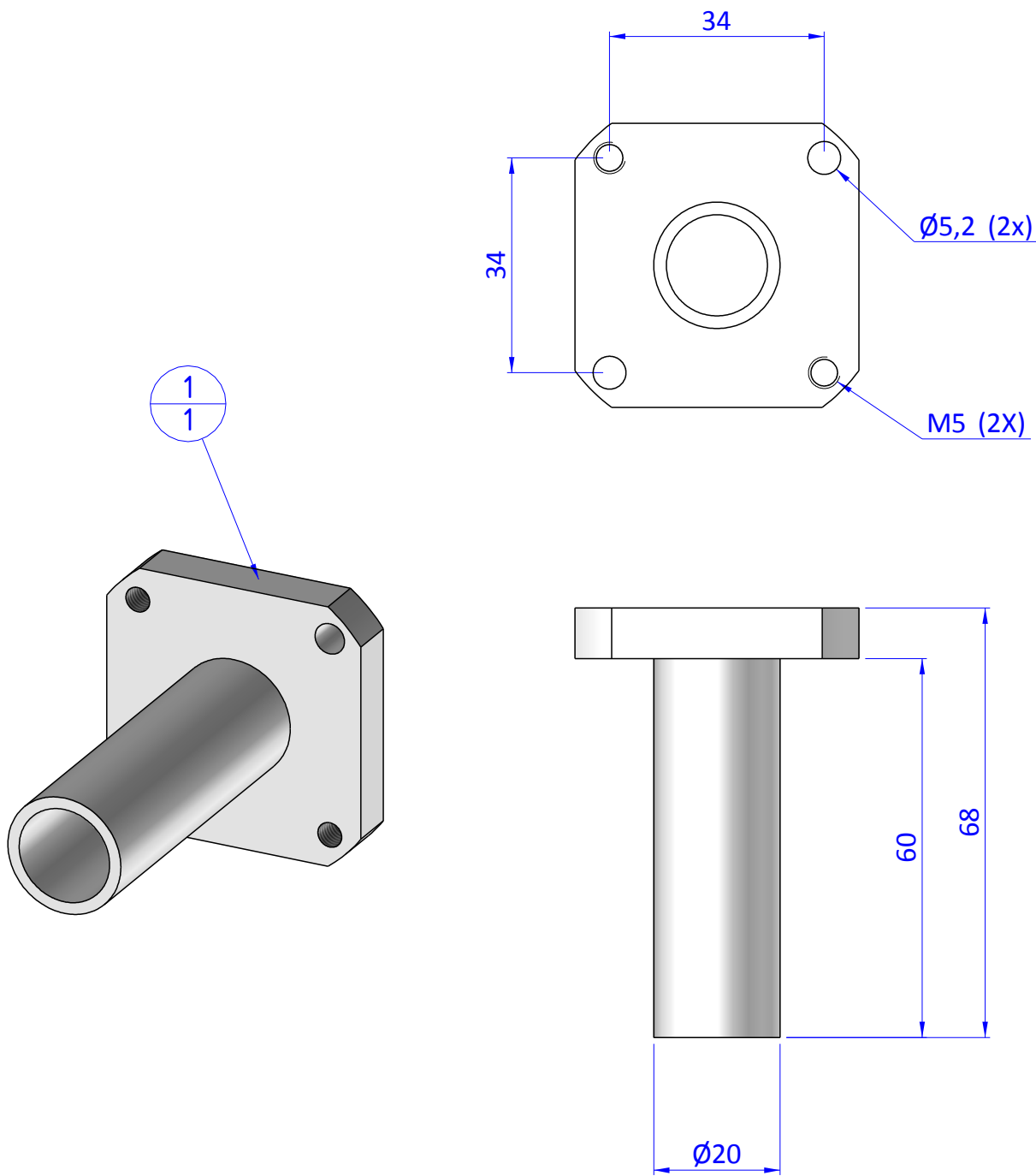

THE PROPERTY OF THE DRAWING IS ESTABLISHED BY LAW. IT IS FORBIDDEN TO PRODUCE OR SHOW IT TO THIRD PART. WITHOUT A WRITTEN AGREEMENT.

Item	Name	Q.ty
1	ADZ.32.20	1

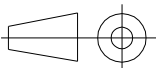

Format A4 UNI 936-76	 FPS FPSERVICES AUTOMATION			DESIGNED FROM FPS Automation	REVIEW A
	GENERAL TOLERANCE UNI - ISO 2768 CLASSE f	DESCRIPTION CA.ADZ.32.20		DATE 16/05/2019	WEIGHT 0,055kg
				CODE CA.ADZ.32.20	